

POOL CLEANING EQUIPMENT



- 260 • Net'N'Clean integrated cleaning system
- 262 • Automatic suction cleaners
- 265 • Pool cleaners pumps
- 267 • Manual suction cleaners
- 269 • Handles
- 270 • Suction hoses
- 272 • Brushes
- 274 • Leaf skimmers
- 275 • Cleaning kits
- 276 • Hydrocleaners

NET'N'CLEAN INTEGRATED CLEANING SYSTEM

NET 'N' CLEAN

Integrated cleaning system

The NET'N'CLEAN is an efficient cleaning system, consisting of a six outlet distributor valve that receives clean water from the filter and distributes it sequentially to a series of nozzles installed on the pool floor.

As pressurised water exits the nozzles, it lifts dirt from the bottom into suspension to be collected by the skimmer and the drain. The Net 'n' Clean offers a more efficient and cost effective alternative to other cleaning systems as it provides a more uniform distribution of the pool temperature and chemicals.

INSTALLATION DIAGRAM

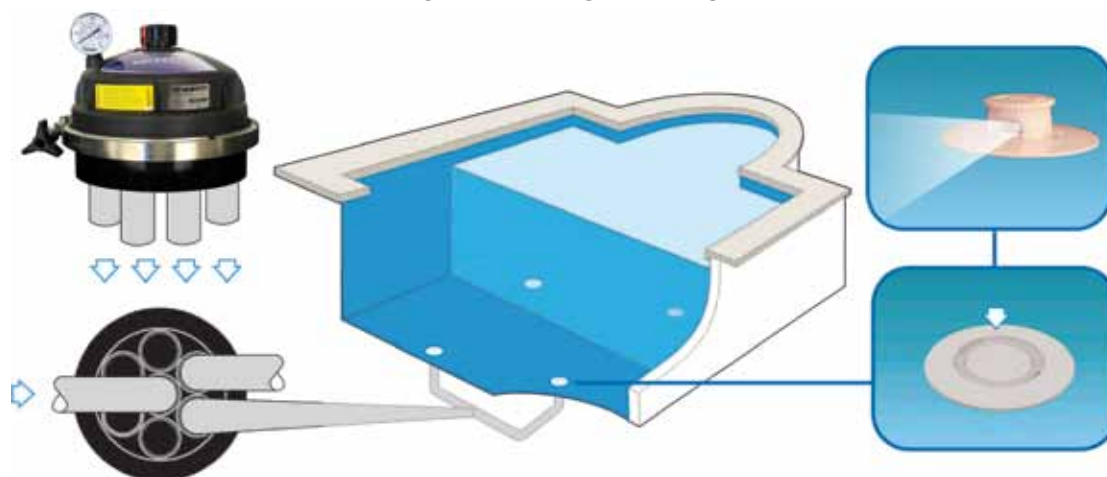

Net'n'Clean distributor valve Ø 50 mm



Six way distribution valve. This valve is part of the Net'n'Clean cleaning system which is integrated in the pool floor. It distributes water sequentially through its various branches. Made of plastic and titanium it has high resistance to salt water. Maximum working pressure: 1.4 bars. Maximum flow: 15 m³/h. Connections: 7 x Ø 50 mm. 2 pop-up nozzles for branch recommended.

Net'n'Clean distributor valve:
European model

Code	Standard Packing	Standard Weight kg	Standard Volume m ³
21257	1	1.7	0.015



Net'N'Clean distributor valve Ø 63 mm



Distributor valve optimized for greater hydraulic performance. Maximum working pressure of 1.8 bars. Maximum flow of 24 m³/h. Connections: 7 x Ø 63 mm or 7 x Ø 75 mm. From 2 to 4 nozzles per branch.

Net'N'Clean distributor valve Ø 63 mm

Code	Standard Packing	Standard Weight kg	Standard Volume m ³
35079	1	5.6	0.031



Net'N'Clean reducing wall conduit for nozzles



Reducing conduit to install concrete Net'N'Clean nozzles (26985). Made in white PVC. Ø 50 mm inside & Ø 63 mm outside connections.

Code	Standard Packing	Standard Weight kg	Standard Volume m ³
21248	12	7.3	0.032

NET'N'CLEAN INTEGRATED CLEANING SYSTEM



Net'N'Clean nozzle

Net'N'Clean nozzle range with 4 different hole configurations. We recommend S4 for the floor and S1 and S2 for the steps. Designed for concrete, liner and fibreglass pools.

The flow rates and radius of action according to the outlet chosen on the nozzle are:

Outlet	Combination	Flow x nozzle m ³ /h	Cleaning length in metres	Outlet surface in mm ²
S1	B+D	2.5	0.60	50
S2	A+D	4	1.25	100
S3	B+C	5	1.80	150
S4	A+C	5	1.80	200

In bold type, the configuration supplied from factory.

Code	Standard Packing	Standard Weight kg	Standard Volume m ³
------	------------------	--------------------	--------------------------------

For concrete pools:

With swivel joint	26985	12	4.14	0.02
Fixed	26986	12	3.78	0.02

For liner pools:

Fixed self threaded PN10	28499	12	5.05	0.034
With metallic insert PN10	28500	12	5.05	0.034
With swivel joint, with inserts	43584	12	5.64	0.033
With swivel joint, with self-tappers	43585	12	5.30	0.033

For Fibreglass pools:

Fixed	21209	12	5.05	0.034
-------	--------------	----	------	-------

On demand can be supplied with the following colours: Sky blue, Navy blue, Grey metal flake, Grey metal and Black.



Concrete



Concrete



Fibreglass



Liner

Concrete

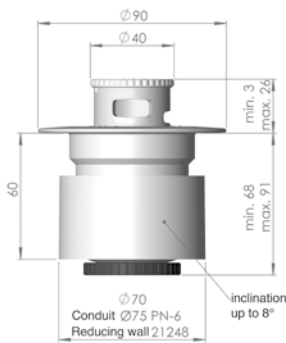

Liner

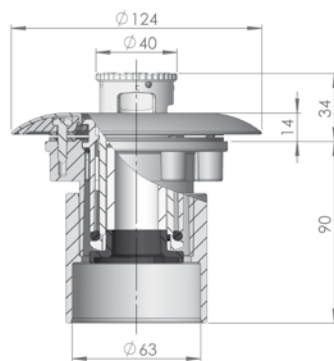

Fibreglass

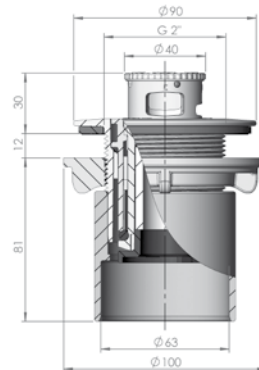

We will not be held responsible for any malfunction or other problems deriving from an incorrect installation. To avoid any such problems, please follow the instructions outlined in the installation manual.

NET'N'CLEAN INTEGRATED CLEANING SYSTEM



new



Wall conduit Ø 90 mm

PVC plastic wall conduit. Cutting area of 120 mm to adjust it to the wall or to the background of the pool. Ø63 or Ø75 connection as preferences.

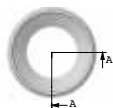
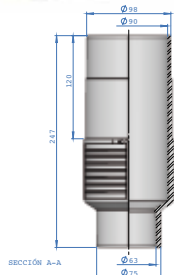

Net'N'Clean electronic integrated cleaning system

The Net'N'Clean electronic recommended for public or large private pools is equipped with an electronic panel that automatically controls a series of solenoid valves used to open or close water flow to each nozzle branch. Computer controlled. Controls up to 12 electrovalves. Maximum flow rate: 18 m³/h for each valve.

- 4 valve system
- 6 valve system
- 8 valve system
- 10 valve system
- 12 valve system

	Code	Standard Packing	Standard Weight kg	Standard Volume m ³
4 valve system	32388	1	16.55	0.260
6 valve system	22512	1	24.83	0.260
8 valve system	22514	1	31.10	0.029
10 valve system	22516	1	35.40	0.029
12 valve system	22518	1	39.70	0.029

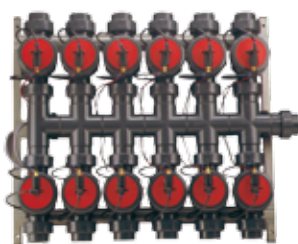

AUTOMATIC SUCTION CLEANERS



new

Bolero ND

Automatic suction pool cleaner with a membrane system suitable for all types of pools. It uses the pump filtration circuit as an energy source. The cleaner can climb walls and vacuum the dirt from the floor. Easy installation and maintenance. It is supplied with fittings that measure and control the waterflow, so it ensures the best performance in the pool. In order to cover the entire surface of the pool, it includes 12 sections of flexible hose (1 metre each), and a deflector ring that prevents the Bolero ND getting trapped.

	Code	Standard Packing	Standard Weight kg	Standard Volume m ³
	43395	1	7	0.092

AUTOMATIC SUCTION CLEANERS

Aspid

Automatic suction cleaner for using in any pool. Made of plastic parts and lead counter weights. Mat made of TPU for better flexibility. Oscillation achieved by a ball and a piston closing the two inlets alternatively. A wheel is easily fitted to the hose permitting a quick change of the position.

Code	Standard Packing	Standard Weight kg	Standard Volume m ³
41365	1	7	0.092



Mamba

Mamba can be installed in minutes without any tools and requires no alteration to your pool. It can be adopted to flat-bottomed or sloped pools and can be used in above ground pools. It is connected directly to the skimmer or the suction line. It works by suction with no need of electricity using the existing filtration system (4m³/h minimum). It is supplied with a 10 m special hose for greater efficiency. It is a cleaner and also a mobile main drain. It is supplied with a pressure regulator to ensure constant flow.

Code	Standard Packing	Standard Weight kg	Standard Volume m ³
38467	1	8.1	0.061



Mamba XS

new

The main application is to clean the bottom of a above ground pool. It is a portable auto cleaner for above ground swimming pools. It can work with 70cm height of water and pumps up to 0,5Hp. It is manufactured in ABS and TPU, the product can resist chemicals and temperature variations for years. The product size is small, so it can be operated conveniently in above ground swimming pools with small pumps/flow rates. Standard autocleaners must have at least 1m height of water in the swimming pool to work. This one can work in swimming pools with a water height lower than 1m. That makes it very convenient for small above ground pools. It can run also with low power pumps.

Code	Standard Packing	Standard Weight kg	Standard Volume m ³
45751	1	8,1	0,061



Hybrid S-30

new

Hybrid S30 is the only pool suction cleaner with an active brushing system and a computerised scanning system to ensure that every part of a pool is cleaned. It offers the same benefits as pool vacuum cleaners but it moves intelligently across the pool like any electronic system. It uses the water flow to generate the energy necessary inside it so that the electronic system cleans the bottom of the pool systematically and accurately. Cleans the bottom of 10 x 6 pools. Its cleaning cycle depends on the pool's filtering system.

Code	Standard Packing	Standard Weight kg	Standard Volume m ³
45870	1	-	-



Dolphin Easyklean

Basic automatic pool cleaner equipped with scanning logic system to clean the entire pool. Filter bag of 70 microns. Cleans the floor and the bottom of the walls. Cleaning cycle time 3 hours. Easy maintenance. For maximum 12 m x 12 m pools.

Code	Standard Packing	Standard Weight kg	Standard Volume m ³
34203	1	27	0.195



AUTOMATIC SUCTION CLEANERS



Dolphin Superkleen

Automatic pool cleaner with self programming to guarantee an ideal cleaning of the pool. Clean the walls and the water-line. Air sensor for each entry pools. Two cleaning cycles, 1 hour and 3 hours. 20 meters of cable. Caddy for easy carrying and storage. For maximum 12 m x 12 m pools.

	Code	Standard Packing	Standard Weight kg	Standard Volume m ³
With PVC brush	34204	1	7.61	0.11
With Wonder brush	34204-0100	1	7.61	0.11
With Combined brush	34204-0110	1	7.61	0.11



Dolphin Ultrakleen

Functional design and offers several new technological features. Scanning system with shorter cycle time. New power supply with a pilot light to indicate that the filter strainer is full. 20 m cable. Includes remote control and swivel system to provide smooth uninterrupted current and signal to the robot. Cycle time 2/3/4 hours (standard 3 hours). For maximum 12 m x 12 m pools.

	Code	Standard Packing	Standard Weight kg	Standard Volume m ³
With PVC brush	34205	1	21.6	0.15
With Wonder brush	34205-0100	1	21.6	0.15
With Combine brush	34205-0110	1	21.6	0.15



Dolphin Dynamic Prox2

Ideal for all types of pools. It has a number of cleaning programs. It scans the bottom of the pool. Thorough cleaning. Frequency for climbing walls. It includes a remote control and a swivel to prevent cables from tangling. For pools of up to 25 x 12 m.

	Code	Standard Packing	Standard Weight kg	Standard Volume m ³
With combined brush	46016	1	20	0,15
With wonder brush	46016-0100	1	20	0,15



Dolphin Wave

Professional pool cleaners for Olympic-size and public pools. Equipped with an intelligent navigation system that ensures complete cleaning of any type of pool. Active brush system made up of rotating brushes. State-of-the-art interactive digital control panel. Intelligent manoeuvring device that allows you to get it in and out of the pool easily. For maximum 25 m x 60 m pools.

	Code	Standard Packing	Standard Weight kg	Standard Volume m ³
	38914	1	25	-



Dolphin 2 x 2

Not requiring installation. Does not require connection to any external filters or pumps. Operates only on 24 V (operates with a built-in power supply). Handles more than 37.850 l/h. Fitted with two drive motors. Algae can be removed. Fitted with remote control. Infra-red system to avoid obstacles. For up to 25 x 60 m pools. 40 meters cable.

	Code	Standard Packing	Standard Weight kg	Standard Volume m ³
Dolphin 2 x 2 with PVC brush	21585-0100	1	37	0.209
Dolphin 2 x 2 with Combined brush	21585-0110	1	37	0.209
Dolphin 2 x 2 with Wonder brush	21585-0120	1	37	0.209
Caddy Dolphin 2 x 2	21585R5014	1	13	0.123



POOL CLEANERS PUMPS

Multi-cellular pump for use with automatic cleaners

1 HP single phase multi-cellular pump. Pump body in noryl with fibreglass. Shafts and screws in Stainless Steel AISI-316. Mechanical seal in S.S. and Graphite. Motor: protection IP-55, isolation class F, non-stop operation, 2850 r.p.m.

Code	Standard Packing	Standard Weight kg	Standard Volume m ³
25452	1	-	-



Performance curves

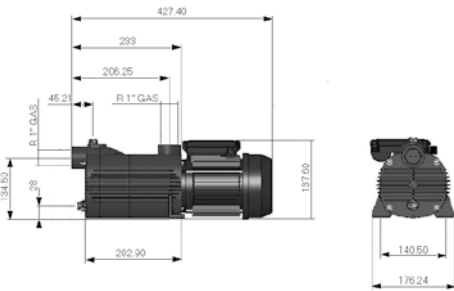
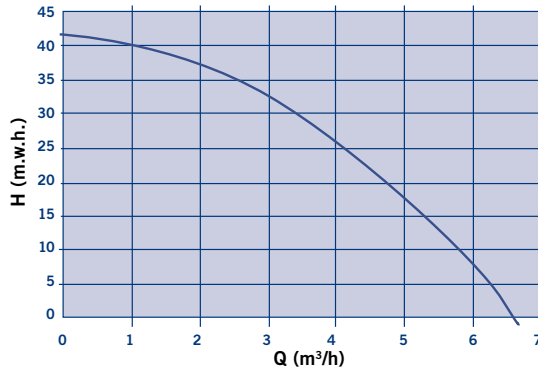

Ontario pump

The new multicellular pump has been especially designed for use with pool cleaning equipment, but it is also suitable for domestic irrigation and domestic pressure applications. This small pump is manufactured in plastic, and the metal parts coming into contact with water are made of AISI-316 Stainless Steel. It is fitted with a high pressure, highly resistant pure graphite mechanical seal, making it ideal to withstand extreme working conditions.

Code	Standard Packing	Standard Weight kg	Standard Volume m ³
34396	1	7.8	0.049

1½" HP Ontario Pump



Performance curves

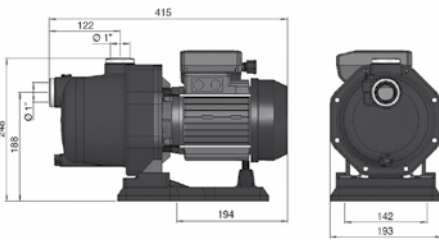
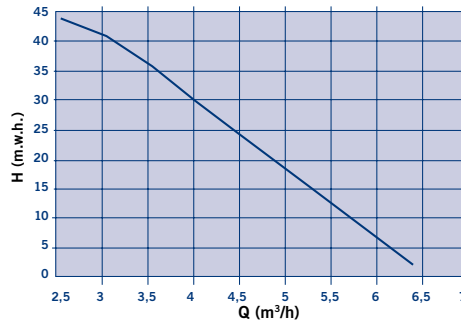

Pool cleaner pump trolley

In anodized Aluminium pipe and plastic platform 460 mm x 370 mm. Accessories in S.S. AISI-304.

Code	Standard Packing	Standard Weight kg	Standard Volume m ³
04648	1	8.06	0.12





**Exclusivity and reliability
guaranteed for your pool
maintenance needs.**

Introducing the **Shark** Series, a new generation of pool maintenance accessories.

Featuring exclusive, cutting edge designs, the **Shark** Series range of accessories stand out thanks to their strength and effectiveness in carrying out basic pool maintenance.



MANUAL SUCTION CLEANERS

Oval model Shark

Manufactured in ABS with a brush made from polypropylene. This model features a hose connection with a choice of two diameters (Ø 32-38 mm). With wing-nut or wishbone fixing.

	Code	Standard Packing	Standard Weight kg	Standard Volume m ³
With wing-nut or wishbone fixing	40997	1	-	-



Oval model

With safety valve to limit suction.

	Code	Standard Packing	Standard Weight kg	Standard Volume m ³
With wishbone fixing	25788	1	-	-



Flexible model Shark

The perfect item for cleaning small particles or sand from the pool bottom. Manufactured in hard-wearing polyethylene (EVA), this model features a hose connection with a choice of two diameters (Ø 32-38). Weight is injected (without caps) which, together with its great flexibility, ensures perfect pool floor cleaning.

	Code	Standard Packing	Standard Weight kg	Standard Volume m ³
With wing-nut or wishbone fixing	36618	1	-	-



Triangular model Shark

Triangular pool cleaner manufactured in ABS with a brush made from polypropylene. This model features a hose connection with a choice of two diameters (Ø 32-38 mm). With wing -nut or wishbone fixing.

	Code	Standard Packing	Standard Weight kg	Standard Volume m ³
With wing-nut or wishbone fixing	36619	1	-	-



Articulated model

For concrete pools. Ideally designed for walls and corners. Brushes made of Polypropylene. 1½" connection. Made of unalterable plastic.

	Code	Standard Packing	Standard Weight kg	Standard Volume m ³
With wing-nut fixing	01349	1	1.0	0.007
With wishbone fixing	01350	1	1.0	0.007



MANUAL SUCTION CLEANERS

Anodised aluminium vac-head



For wing-nut fixing:

350 mm for 1½" hose
450 mm for 2" hose
450 mm for 1½" hose

For wishbone fixing:

350 mm for 1½" hose
450 mm for 2" hose

Code	Standard Packing	Standard Weight kg	Standard Volume m ³
01353	4	11.8	0.04
01354	4	15.5	0.06
08661	4	15.5	0.06
01355	4	11.8	0.04
01356	4	15.5	0.06

new

Shark injected aluminium pool cleaner



Pool cleaner made of injected aluminium and plastic. Connections of Ø 32-38 mm for Ø 1 ½ hoses.

Shark handle attachment by means of clip and bracket.



Code	Standard Packing	Standard Weight kg	Standard Volume m ³
41625	1	-	-



Double length metal vac-head



In polished anodized aluminium and chromed brass. 2" connection, length 800 mm. Telescopic handle and cable models (cable not included). The float line cable 00210 can be used.

Trailed via cable
Touse with handle with wing-nut fixing

Code	Standard Packing	Standard Weight kg	Standard Volume m ³
01357	1	13.0	0.03
16601	1	13.0	0.03



Anodised aluminium and chromed brass vac-head



Inner connection for 1½" hose and outer for 2" hose. S.S. connecting fork. Wing-nut fixing. Lenght 442 mm.

Code	Standard Packing	Standard Weight kg	Standard Volume m ³
01358	4	23.2	0.05

HANDLES

System connection	C.A.	C.A. - Wishbone					C.A. Wing-nut						
Code	01365	38422	38423	38424	38425	01359	01360	01361	01362	01363	01364	15838	
A		1.8	2.4	2	2.5	2	2.5	2.5	5	6.5		3.75	
B	2.5	3.6	4.8	4	5	4	5	5	10	13	2.5	7.5	
Telesc.	Normal		•	•	•	•	•						
	Reinforced							•	•	•		•	
FIXED	•										•		

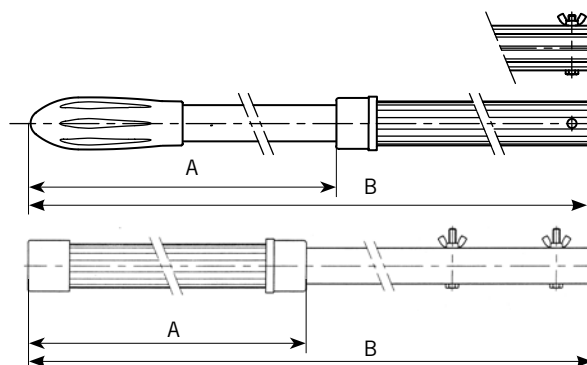

For wing-nut fixing

Aluminium fixed length 2.5 m.

Code	Standard Packing	Standard Weight kg	Standard Volume m ³
01364	20	11.4	0.06



For wishbone fixing

Aluminium fixed length 2.5 m.

Code	Standard Packing	Standard Weight kg	Standard Volume m ³
01365	12	10.2	0.06



Telescopic poles for wing-nut fixing

Aluminium, telescopic 2 - 4 m
Aluminium, telescopic 2.5 - 5 m

Code	Standard Packing	Standard Weight kg	Standard Volume m ³
01359	12	13.4	0.05
01360	12	16.2	0.06



Telescopic poles for wing-nut or wishbone fixing Shark series

From 1.8 m up to 4.8 m.

Aluminium, telescopic 1.8 - 3.6 m
Aluminium, telescopic 2.4 - 4.8 m

Code	Standard Packing	Standard Weight kg	Standard Volume m ³
38422	10	11.7	0.05
38423	10	14.4	0.06



Telescopic poles for wing-nut or wishbone fixing Shark series

From 2 m up to 5 m.

Aluminium, telescopic 2 - 4 m
Aluminium, telescopic 2.5 - 5 m

Code	Standard Packing	Standard Weight kg	Standard Volume m ³
38424	12	13.6	0.05
38425	12	16.4	0.06



HANDLES



For wing-nut connection - reinforced, telescopic



	Code	Standard Packing	Standard Weight kg	Standard Volume m ³
Reinforced, telescopic 5 m in aluminium	01361	5	16.0	0.04
Reinforced, telescopic 7.5 m in aluminium	15838	1	6.0	0.01
Reinforced, telescopic 10 m in aluminium	01362	1	6.5	0.02
Reinforced, telescopic 13 m in aluminium	01363	1	8.4	0.02

Handle adapter



For converting wing-nut fixing system to wishbone fixing system.

	Code	Standard Packing	Standard Weight kg	Standard Volume m ³
Adapts the wishbone connection handle to wing nut	14592	48	3.36	0.01
Adapts the wing nut connection handle to wishbone	08465	-	-	-
Adapts the reinforced wing nut connection handle to wishbone	17937	-	-	-

SUCTION HOSES



Hose connectors



	Code	Standard Packing	Standard Weight kg	Standard Volume m ³
Ø 38 mm for connections to inlets 16328, 16329, 16330, in white ABS	05684	12	1.0	0.003
Ø 50 mm connections to inlets 00315, grey PP	01392	12	1.0	0.006

Hose fitting



White ABS plastic.

	Code	Standard Packing	Standard Weight kg	Standard Volume m ³
For Ø 38 mm hose, male thread 1½"	01393	12	1.0	0.006

SUCTION HOSES

Floating suction hose

Transparent blue Polyethylene hose.

	Code	Standard Packing	Standard Weight kg	Standard Volume m ³
Ø 38 mm (1½")	01372	30 m	8.0	0.108
Ø 50 mm (2")	01373	30 m	14.0	0.192

Floating suction hose

Blue plastic. Includes connecting cuffs., except in the 30 m hose (01374, 01379).

	Code	Standard Packing	Standard Weight kg	Standard Volume m ³
Ø 38 mm (1½")				
30 m	01374	1	12.0	0.192
15 m	01375	1	5.6	0.192
12 m	01376	1	4.5	0.192
10 m	01377	1	3.0	0.192
8 m	01378	1	3.0	0.192
Ø 50 mm (2")				
30 m	01379	1	15.0	0.240

Hose cuffs

	Code	Standard Packing	Standard Weight kg	Standard Volume m ³
Made in blue PVC				
For Ø 38 mm (01372) hose				
Only for vac inlets 24415	07958	12	2.0	0.003
For Ø 38 mm hose (01372)	01385	12	2.0	0.003
For Ø 50 mm hose (01373)	01386	12	3.0	0.010
Made in flexible white PVC				
For Ø 38 mm hose (01374-01375 01376-01377-01378)	01387	12	2.0	0.030
For Ø 50 mm hose (01379)	01388	12	3.0	0.010



BRUSHES



Straight Brush 180 mm

With handle.

Code	Standard Packing	Standard Weight kg	Standard Volume m ³
09456	14	6.1	0.177



Straight brush 165 mm

Stainless Steel bristles with Aluminium support.

With wishbone fixing

Code	Standard Packing	Standard Weight kg	Standard Volume m ³
01407	20	9.0	0.018



Hand held brush

White Polypropylene support and black bristles. Ideal for water line cleaning.

Code	Standard Packing	Standard Weight kg	Standard Volume m ³
11789	20	3.5	0.027



Pool bottom brush Shark series

Ideal for cleaning the pool floor, due to its large size and special design.

With wing-nut or wishbone fixing

Code	Standard Packing	Standard Weight kg	Standard Volume m ³
36615	1	-	-



BRUSHES



Wall brush Shark series

The angle between the bristles and the handle has been reduced in order to make a brush which adapts to the pool wall, allowing effort-free cleaning.

	Code	Standard Packing	Standard Weight kg	Standard Volume m ³
With wing-nut or wishbone fixing	36616	1	-	-



Pool corner suction brush Shark series

Especially designed for pool corners, this brush features a practical connection to a suction hose.

	Code	Standard Packing	Standard Weight kg	Standard Volume m ³
With wing-nut or wishbone fixing	36617	1	-	-



SPOT-EX water-line eraser

Especially designed to erase scum line stains. With telescopic handle adaptor.

	Code	Standard Packing	Standard Weight kg	Standard Volume m ³
With wishbone fixing	16391	1	0.4	0.005



LEAF SKIMMERS



Water surface model with 1.3 m handle

Including white Polypropylene frame and Polyester net. Push fit aluminium handle.

	Code	Standard Packing	Standard Weight kg	Standard Volume m ³
Shallow net Surface model	01400	12	8.0	0.150



Deep water leaf skimmers Shark series

Manufactured in blue Polypropylene. The Polyester net is welded to the skimmer frame, ensuring greater strength. Its long design maximises collection along the float line.

	Code	Standard Packing	Standard Weight kg	Standard Volume m ³
With wing-nut or wishbone fixing	36614	1	-	-



Water surface leaf skimmer Shark series

Manufactured in blue Polypropylene. The Polyester net is welded to the skimmer frame.

	Code	Standard Packing	Standard Weight kg	Standard Volume m ³
With wing-nut or wishbone fixing	36613	1	-	-



Aluminium leaf net model

With white Aluminium frame and Polyester white net. With wishbone fixing.

	Code	Standard Packing	Standard Weight kg	Standard Volume m ³
Water surface model	23360	14	8.4	0.103
Deep water model	23361	14	8.5	0.103

CLEANING KITS
Cleaning kit n° 1

	Code	Standard Packing	Standard Weight kg	Standard Volume m ³
Kit n° 1	28516	5	13.7	0.15

Kit n° 1

Includes:

- 1 Deep water net (01397)
- 1 Brush (18"), with wishbone fixing (11035)
- 1 Analyser Kit (15196)
- 1 Flexible manual cleaner, with wishbone fixing (07429)
- 1 Dolphin Thermometer (08318)

Cleaning kit n° 2

	Code	Standard Packing	Standard Weight kg	Standard Volume m ³
Kit n° 2	28834	4	9.4	0.15

Kit n° 2

Includes:

- 1 Deep water net (01397)
- 1 Brush (18"), with wishbone fixing (11035)
- 1 Analyser Kit (15196)
- 1 Dolphin Thermometer (08318)
- 1 Triangular manual cleaner, with wishbone fixing (07430)

Cleaning kit n° 3

	Code	Standard Packing	Standard Weight kg	Standard Volume m ³
Kit n° 3	28835	4	10.2	0.15

Kit n° 3

Includes:

- 1 Deep water net (01397)
- 1 Brush (18"), with wishbone fixing (11035)
- 1 Analyser Kit (15196)
- 1 Dolphin Thermometer (08318)
- 1 Oval manual cleaner with wishbone fixing (07084)



HYDROCLEANERS



Water Hydrocleaners up to 40° - PO W 622X

150 EW Bar portable hydrocleaner. Portable for garden cleaning jobs and maintenance of the pool area. 5 m pressure hose. Detergent dispensing bottle. 2 interchangeable jets. Maximum water temperature 40°C.

Technical features:

Q l/h	Ø	W	Voltaje
390	150	1600	230-50

	Code	Standard Packing	Standard Weight kg	Standard Volume m ³
POW 622X	32986	1	9	0.04



Water Hydrocleaners up to 40° - PO W 624

160 EW Bar portable hydrocleaner. For garden cleaning jobs and maintenance of the pool area. 6 m pressure hose. Detergent injection system. Rack to hang accessories. 2 interchangeable jets. 1 rotating brush. "Start-Stop" switch on the pistol. Maximum water temperature 40°C.

Technical features:

Q l/h	Ø	W	Voltaje
360	160	1700	230-50

	Code	Standard Packing	Standard Weight kg	Standard Volume m ³
POW 624	32987	1	13	0.06